

IMPORTANT: Read carefully before installation and retain for future reference.
NOTE: Installation must be conducted by licensed electrician.

StarPower Link LED Luminaire

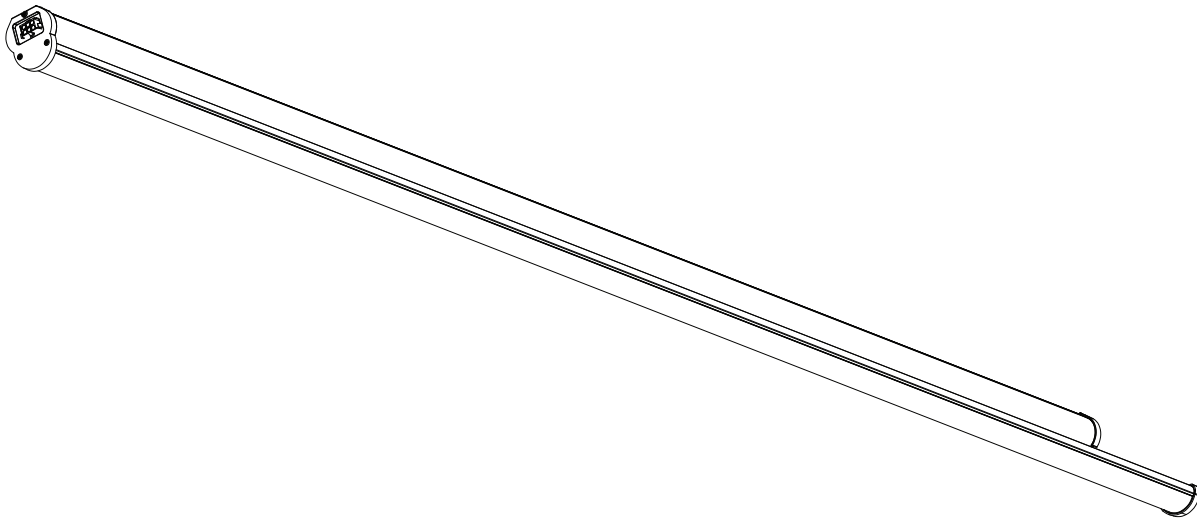

MODEL #s

SP-N-x-LS

SP-W-x-LS











A: Introduction

The light is designed to illuminate commercial, industrial and institutional locations.

StarPower Link can be operated from any nominal 120-277V, 50/60Hz AC supply without any variation in light output. The luminaire is compatible with 0-10V dimmers.

Models SP-x are all suitable for damp location per UL 1598.

B: Warnings

-  **SUITABLE FOR DAMP LOCATIONS.**
CONVIENT AUX EMPLACEMENTS HUMIDES.
-  **THIS PRODUCT MUST BE INSTALLED IN ACCORDANCE WITH THE APPLICABLE INSTALLATION CODE BY A PERSON FAMILIAR WITH THE CONSTRUCTION AND OPERATION OF THE PRODUCT AND THE HAZARDS INVOLVED.**
CE PRODUIT DOIT ÊTRE INSTALLÉ SELON LE CODE D'INSTALLATION PERTINENT, PAR UNE PERSONNE QUI CONNAÎT BIEN LE PRODUIT ET SON FONCTIONNEMENT AINSI QUE LES RISQUES INHÉRENTS.
-  **REMOVE PRODUCT FROM PACKAGING AND CONFIRM IT IS FREE OF DAMAGE PRIOR TO INSTALLATION.**
ENLEVEZ LE PRODUIT DE L'EMBALLAGE ET VERIFIEZ QU'IL N'EST PAS ENDOMMAGE AVANT L'INSTALLATION.
-  **DISCONNECT POWER PRIOR TO ANY INSTALLATION.**
DÉBRANCHEZ LE COURANT AVANT TOUTE INSTALLATION.
-  **CAP ALL WIRING CONNECTIONS WITH UL APPROVED WIRE CONNECTORS.**
COUVRIR TOUTES LES CABLES AVEC DES CONNECTIONS APPROUVES (UL).
-  **VERIFY SUPPLY VOLTAGE MEETS LUMINAIRE LABEL SPECIFICATIONS.**
VÉRIFIEZ QUE LA TENSION SOIT COMPATIBLE AVEC LES CARACTÉRISTIQUES DU LUMINAIRE MARQUE SUR L'ÉTIQUETTE.
-  **ALLOW FIXTURE TO COOL BEFORE TOUCHING HEATSINK OR LIGHT SOURCE.**
LAISSEZ LE PROJECTEUR REFROIDIR AVANT DE TOUCHER LE RADIATEUR OU LA SOURCE DE LUMIÈRE.
-  **DO NOT ATTEMPT TO OPEN OR MAKE REPAIRS INSIDE LUMINAIRE.**
NE PAS TENTER D'OUVRIR OU DE FAIRE DES REPARATIONS A L'INTERIEUR DU LUMINAIRE.
-  **CLEAN LENS, WHENEVER NECESSARY, WITH CLEAN WARM WATER OR A NON-ABRASIVE EPA APPROVED SOLUTION WHICH WILL NOT SCRATCH SURFACE.**
NETOYEZ L'OBJECTIF CHAQUE FOIS QUE NECESSAIRE, A L'EAU TIEDE PROPRE OU AVEC UNE SOLUTION NON ABRASIVE EPA APPROUVEE, ET QUI NE RAYERA PAS LA SURFACE.
-  **AVOID DIRECT VIEWING OF LIGHT SOURCE.**
EVITEZ DE REGARDER DIRECTMENT LA SOURCE LUMINEUSE.
-  **THIS PRODUCT MUST BE INSTALLED BY A QUALIFIED ELECTRICIAN.**
CE PRODUIT DOIT ÊTRE INSTALLÉ PAR UN ÉLECTRICIEN QUALIFIÉ.

C: System Overview

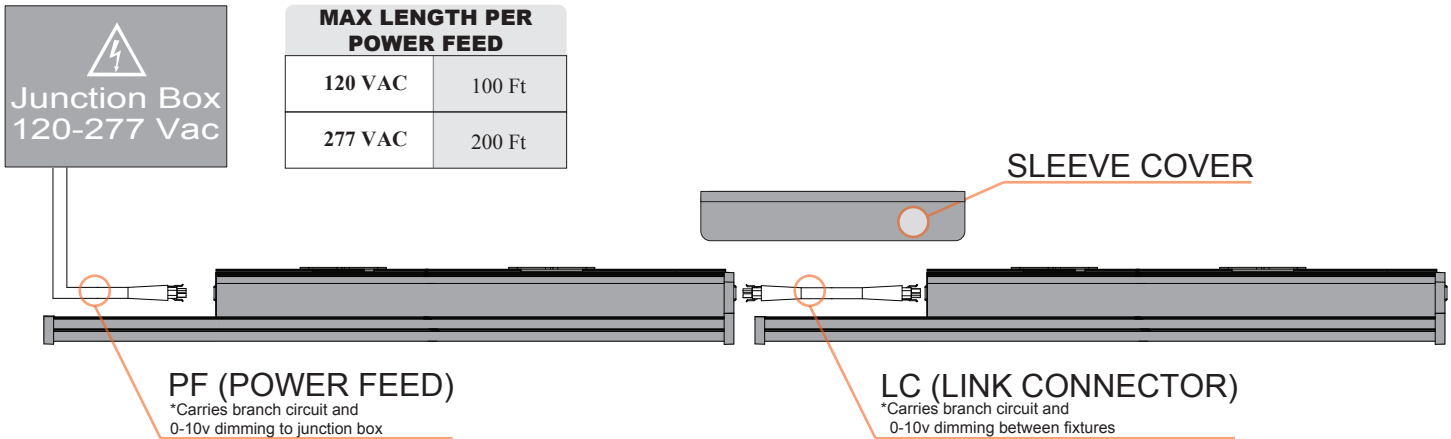

D: Installation

1. Shut off power.
2. Inspect mounting location for damage. Make sure the structure can support the weight of the StarPower Link fixture.

StarPower Fixture Weight

4 ft. fixture 8 lbs. max
8 ft. fixture 16 lbs. max

3. Remove StarPower Link Fixture from package and inspect for damage.
4. Determine mounting method. Follow all UL, NEC and minimum load rating guidelines when selecting and installing a chain, cable, or rod.

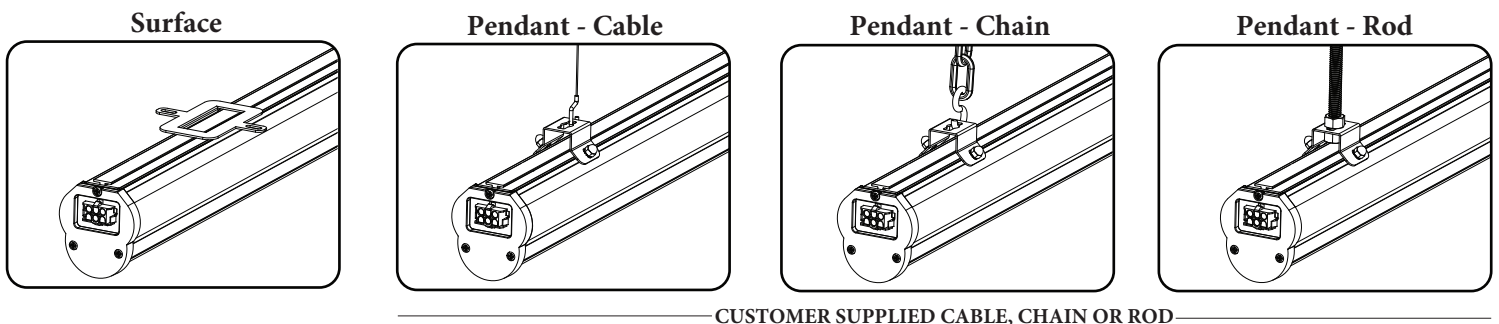

**PROCEED TO
STEP 5**

**PROCEED TO
STEP 10**

Fixture Mounting - Surface

5. If necessary, adjust mount bracket location by sliding bracket to desired position.

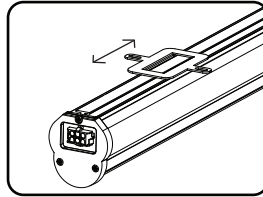

6. Tighten set screw to lock bracket in place.

7. Attach first fixture to structure.

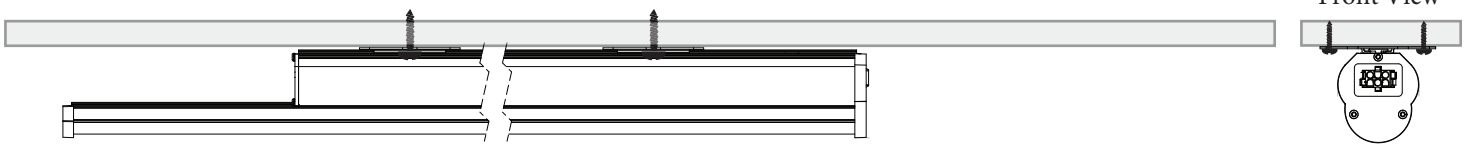

8. Support second fixture and insert **LINK CONNECTOR** from previously installed fixture.

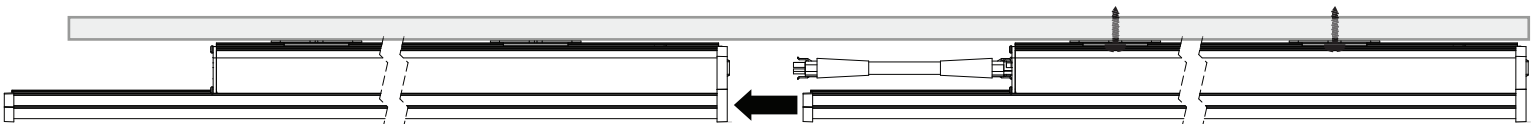

9. Confirm **LINK CONNECTOR** is locked to mating socket and attach fixture to structure.



PROCEED TO STEP 15

Fixture Mounting - Pendant

10. If necessary, adjust mount bracket by loosening (2) cap nuts and sliding pendant mount bracket to desired position.

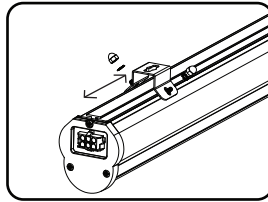

11. Re-install lock washer and cap nut, fully tighten before installing StarPower Link.

12. Attach first fixture to suspension hardware.

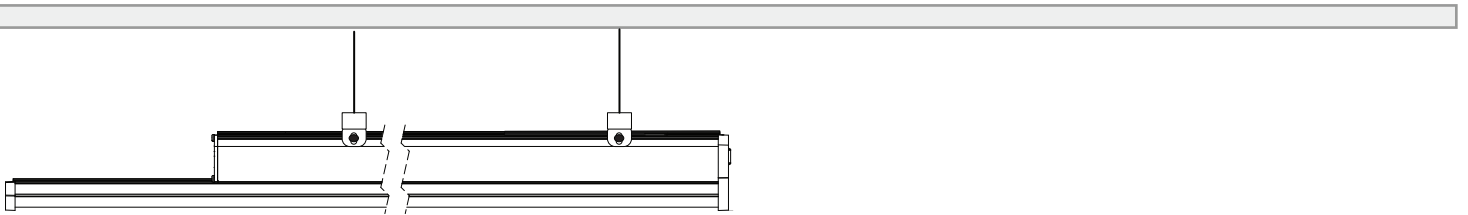

13. Attach second fixture to suspension hardware and align with first fixture.
Insert **LINK CONNECTOR** from first fixture to second and confirm connector has locked to mating socket.

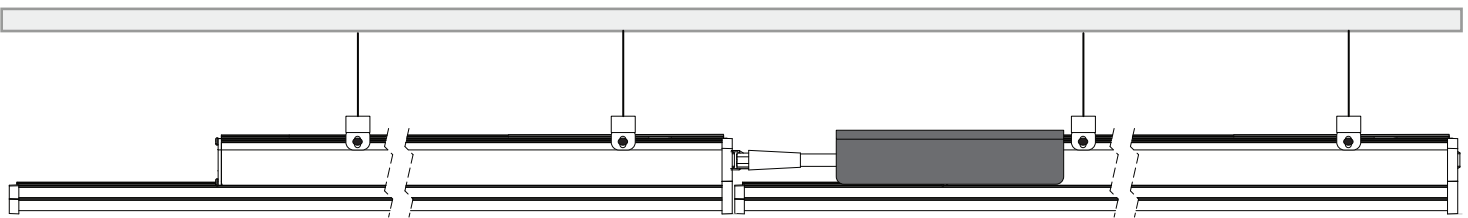

14. Slide **SLEEVE COVER** over exposed end of second fixture.

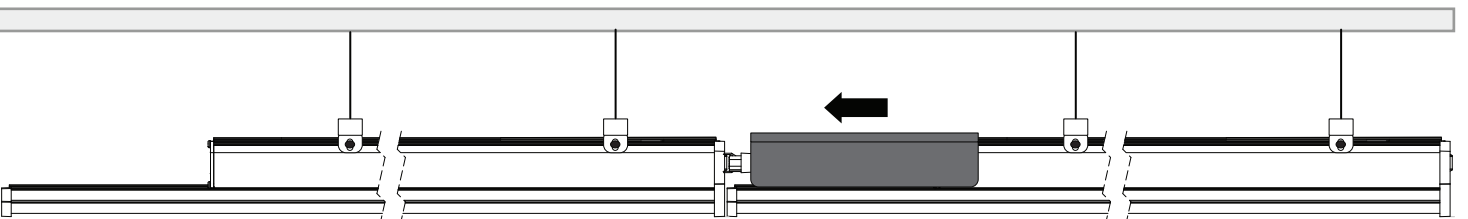

PROCEED TO STEP 15

Power Feed Installation



15. Power must be turned OFF prior to disconnecting or reconnecting **POWER FEED** or **LINK CONNECTORS**.

16. Confirm all fixtures are connected with the provided **LINK CONNECTOR**.

17. Locate **POWER FEED** cord.

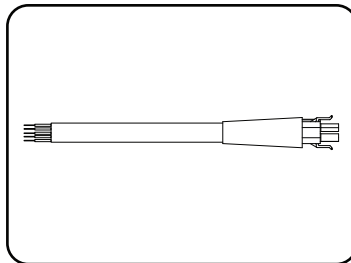

18. Wire non-connector end of **POWER FEED** cord to AC line using NRTL listed wire connectors, junction box and strain relief approved for use with cord diameters of .66".
Green (ground), black (line), white (neutral), pink (positive dimming), orange (negative dimming)
*Refer to fig.1 for wiring diagram

19. Connect **POWER FEED** cord to fixture. **POWER FEED** cord can be connected to either end of StarPower Link fixture.

20. Turn on power.

